

2J6603B

2.4/5.0 GHz ISM and GPS Screw Mount

Key Features

Cable 1: 2.4/5.0 GHz ISM

- 2410-2490 MHz
- 4920-5925 MHz

Cable 2: GPS/QZSS/Galileo

- 1575 MHz

Screw Mount

Anti-Rotation Mechanism

Ground Plane Independent

Customizable Cable and Connector

Dimensions 77.3 x 15 mm



1. Antenna and electrical specifications

Cable 1

Parameters	2.4/5.0 GHz ISM Antenna	
Standards	WiFi, BT, ZigBee, ISM	
Band (MHz)	2.4 GHz	5.0 GHz
Frequency (MHz)	2410-2490	4920-5925
Return Loss (dB)	~-20	~-15
VSWR	~1.2:1	~1.4:1
Efficiency (%)	~35	~33
Peak Gain (dBi)	~-4.3	~-1.8
Average Gain (dB)	~-4.4	~-4.8
Impedance (Ohm)	50	
Polarisation	Linear	
Radiation Pattern	Omni-Directional	
Max. Input Power (W)	25	
Connector Type	Most RF Connectors (SMA-Male Standard)	
Cable Length	Any Cable Length (300 cm Standard)	
Cable Type	Other Cables Available (RG174 Standard)	

Cable 2

Parameters	GPS Antenna
Standard	GPS/QZSS/Galileo
Band (MHz)	1575
Frequency(MHz)	1575.42
Return Loss (dB)	<-20.8dB
VSWR	<1.2:1dB
Impedance	50
Radiation Pattern	Hemispherical
Polarization	RHCP
Saw Filter	
Active Gain (dB)	26 @ 3 V
Noise Figure (dB)	1.2
Voltage (V)	3 – 5
Current (mA)	15 - 25
Power Consumption (mW)	45 - 125
Connector Type	Most RF Connectors (SMA-Male Standard)
Cable Length	Any Cable Length (300 cm Standard)
Cable Type	Other Cables Available (RG174 Standard)

Antenna Measurement Conditions:

Mounted on 30 x 30 cm Ground Plane

200 cm RG174 Cable

Measured in Certified CTIA 3D Anechoic Chamber

2. Mechanical and environmental specifications

Specifications	2J6603B
Mounting Type	Screw Mount
Dimensions (mm)	77.3 x 15
Radome	ASA
Radome color	Black
Antenna Base	Zamak
Gasket	TPE
Operating Temperature (C)	-40 to +85
Storage Temperature (C)	-40 to +85
Substance Compliance	RoHS

3. Antenna parameters

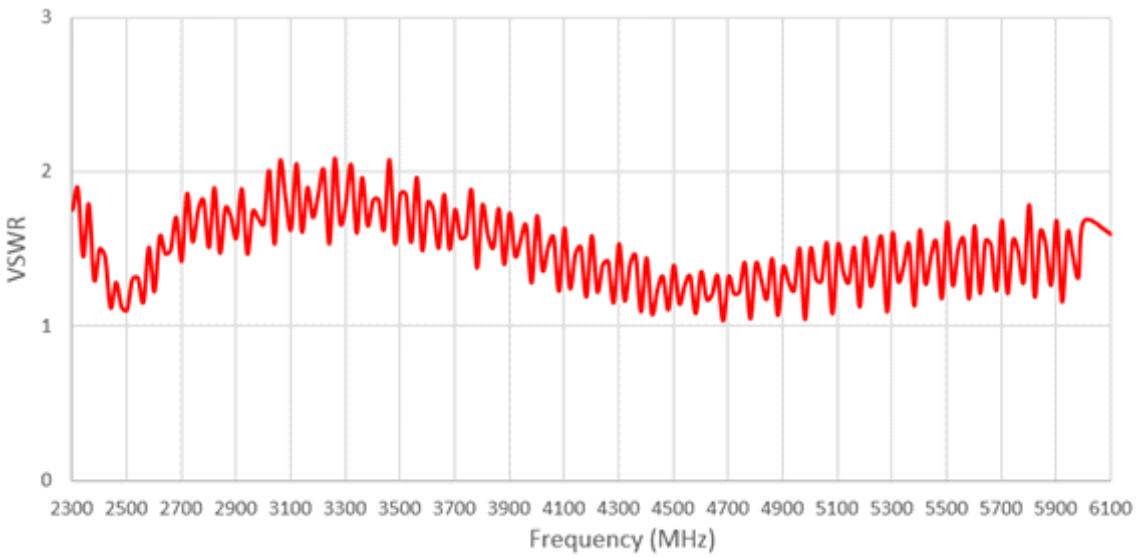
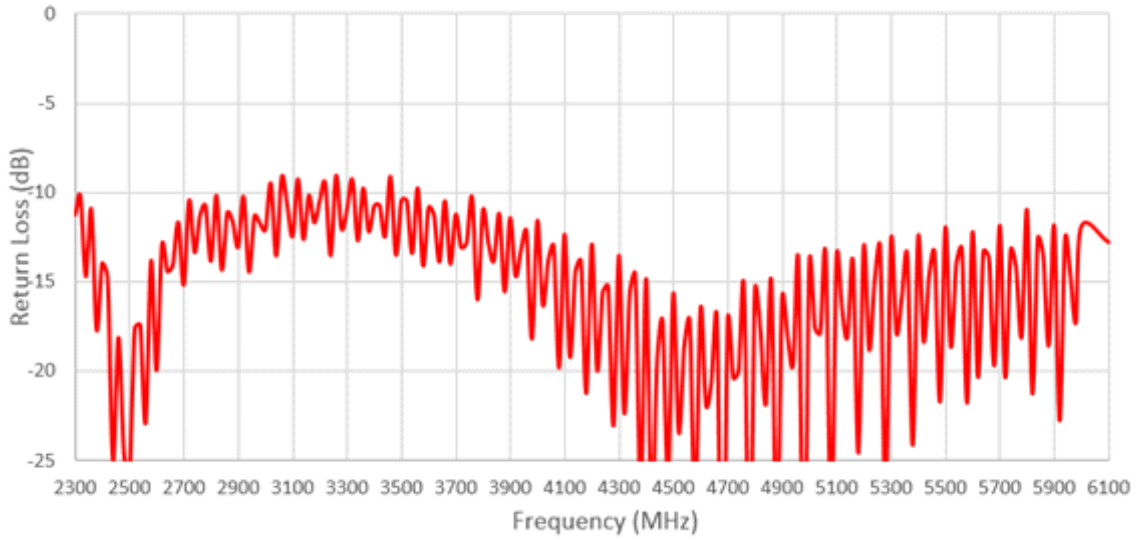

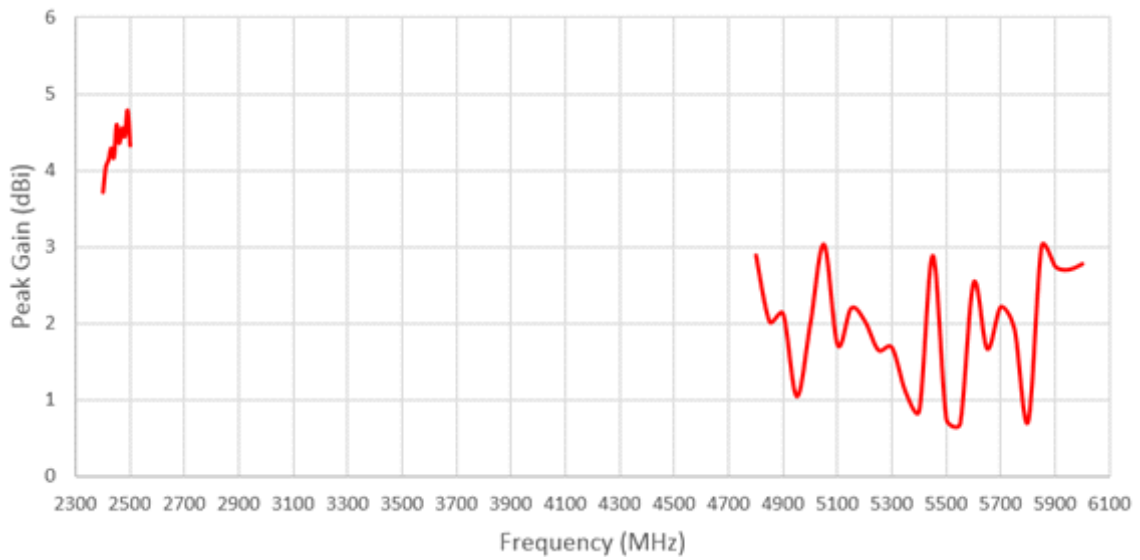
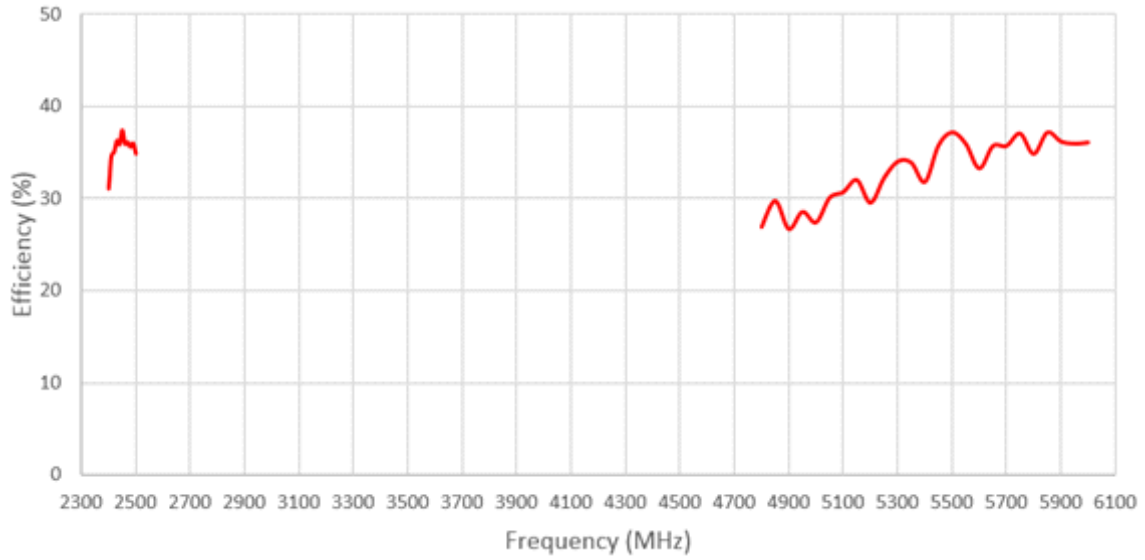

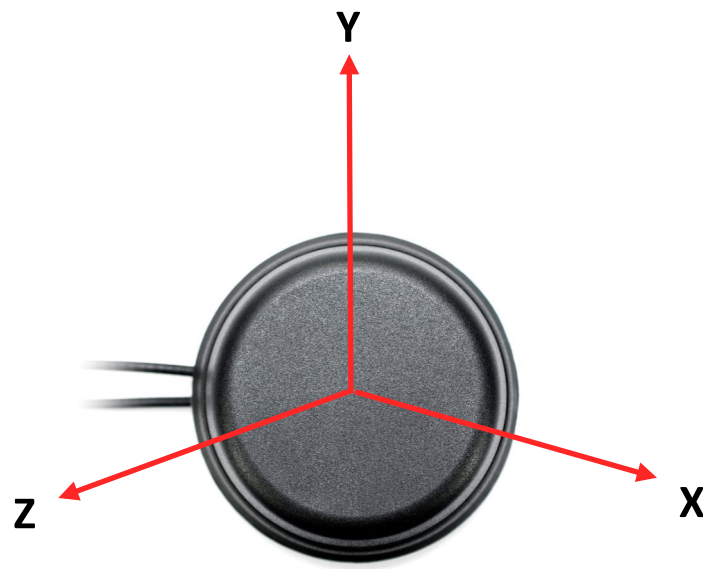
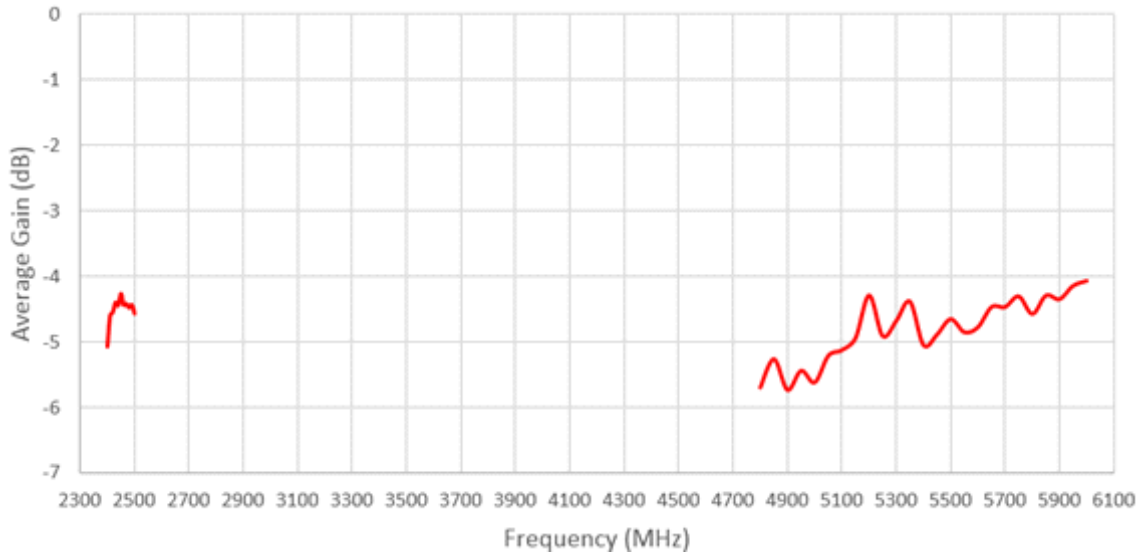

Radiation pattern reference

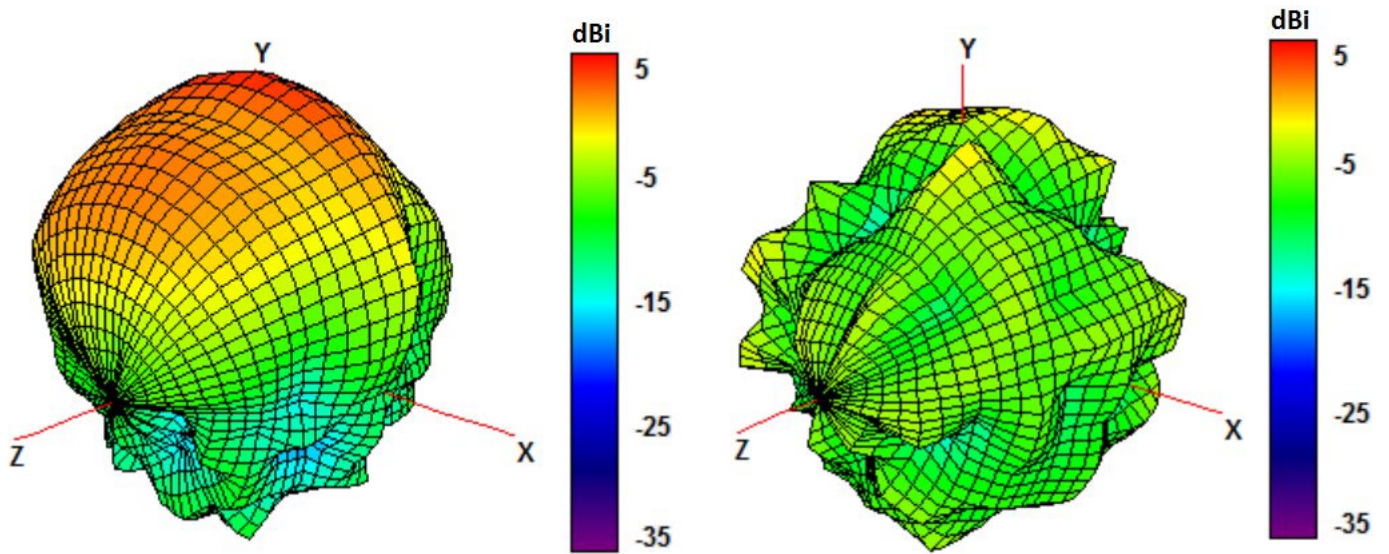

2450 and 5500 MHz Radiation pattern

4. Antenna drawings

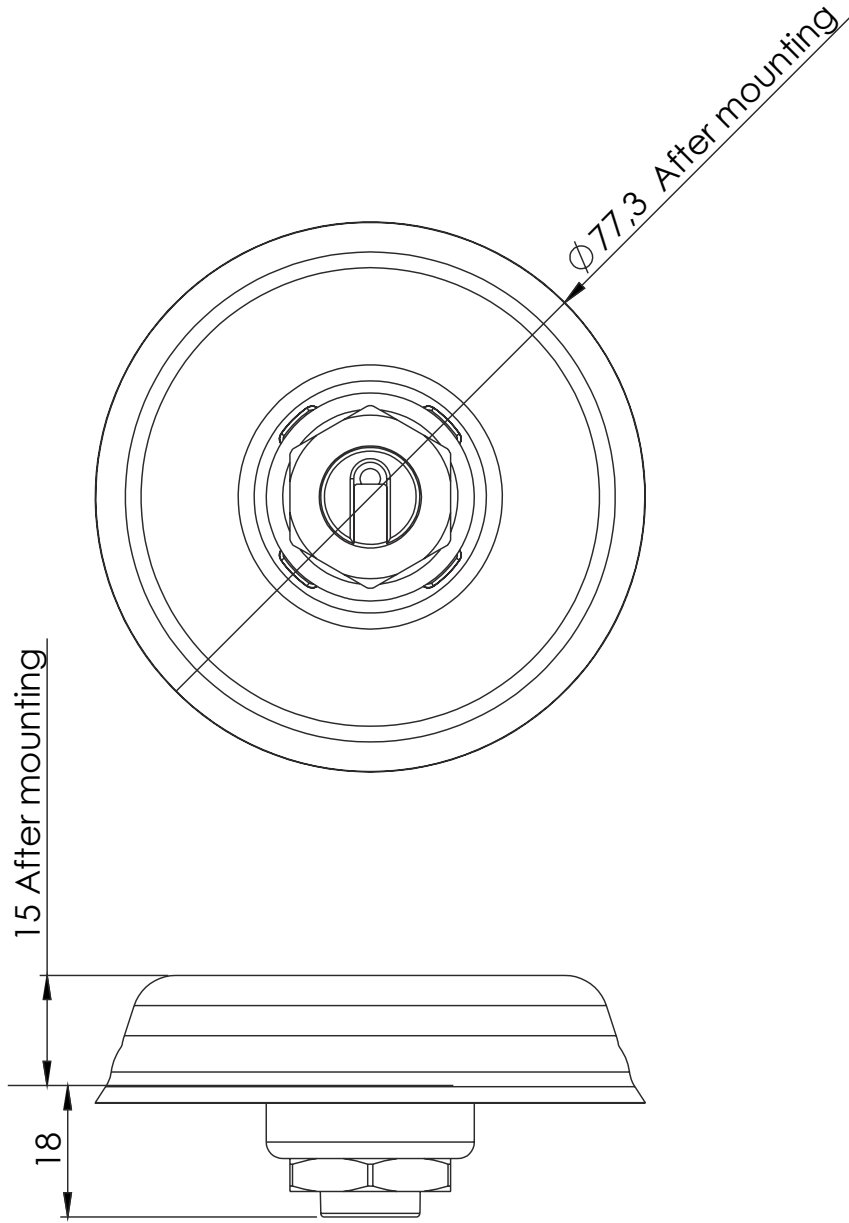

5. Antenna Images

