

## 2J6941BGFa

CELLULAR/LTE MIMO and GNSS Screw Mount

### Key Features

**Cable 1 and 2: CELLULAR / LTE**

- 698-960 MHz
- 1710-2170 MHz
- 2500-2700 MHz

**Cable 3: GPS/GLONASS/QZSS/Galileo**

- 1575-1606 MHz

Screw Mount

Anti-Rotation Mechanism

High Performance

Ground Plane Independent

Customizable Cable and Connector

Dimensions 80 × 74 × 25.6 mm

Certificates: IP67, IP69



## 1. Antenna and electrical specifications

Cable 1

Parameters	CELLULAR / LTE Antenna		
<b>Standards</b>	2G,3G and 4G		
<b>Band (MHz)</b>	700/850/900	1700/1800/1900/2100	2600
<b>Frequency (MHz)</b>	698-960	1710-2170	2500-2700
<b>Return Loss (dB)</b>	~-11.7	~-7.9	~-21.6
<b>VSWR</b>	~2.0:1	~2.4:1	~1.2:1
<b>Efficiency (%)</b>	~42.5	~40.1	~48.0
<b>Peak Gain (dBi)</b>	~-2.6	~-4.0	~-5.5
<b>Average Gain (dB)</b>	~-3.8	~-4.4	~-3.2
<b>Impedance (Ohm)</b>	50		
<b>Polarisation</b>	Linear		
<b>Radiation Pattern</b>	Omni-Directional		
<b>Max. Input Power (W)</b>	25		
<b>Connector Type</b>	SMA-Male Standard (Other Connectors Available)		
<b>Cable Length</b>	300 cm Standard (Any Cable Length Available)		
<b>Cable Type</b>	D302 Standard (Other Cables Available)		

Cable 2

Parameters	CELLULAR / LTE Antenna		
<b>Standards</b>	2G,3G and 4G		
<b>Band (MHz)</b>	700/850/900	1700/1800/1900/2100	2600
<b>Frequency (MHz)</b>	698-960	1710-2170	2500-2700
<b>Return Loss (dB)</b>	~-12.0	~-7.9	~-20.7
<b>VSWR</b>	~1.9:1	~2.4:1	~1.2:1
<b>Efficiency (%)</b>	~41.2	~40.4	~48.0
<b>Peak Gain (dBi)</b>	~-1.3	~-4.1	~-6.0
<b>Average Gain (dB)</b>	~-4.0	~-4.4	~-3.2
<b>Impedance (Ohm)</b>	50		
<b>Polarisation</b>	Linear		
<b>Radiation Pattern</b>	Omni-Directional		
<b>Max. Input Power (W)</b>	25		
<b>Connector Type</b>	SMA-Male Standard (Other Connectors Available)		
<b>Cable Length</b>	300 cm Standard (Any Cable Length Available)		
<b>Cable Type</b>	D302 Standard (Other Cables Available)		

**Antenna Measurement Conditions:**

Mounted on Metal Plate of 30 x 30 cm  
 200 cm of Cable D302  
 Measured in Certified CTIA 3D Anechoic Chamber

Cable 3

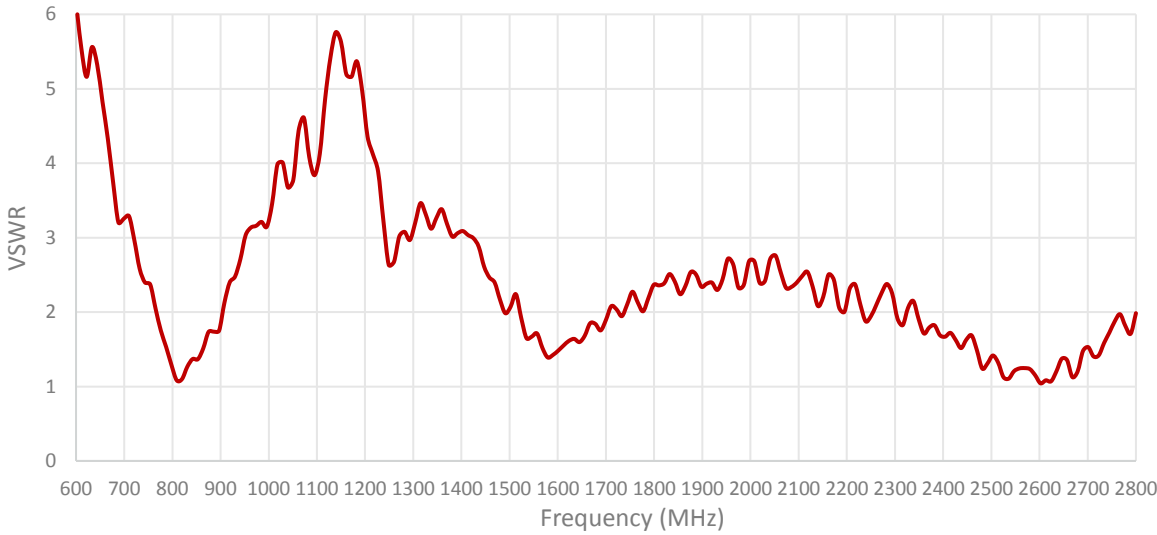
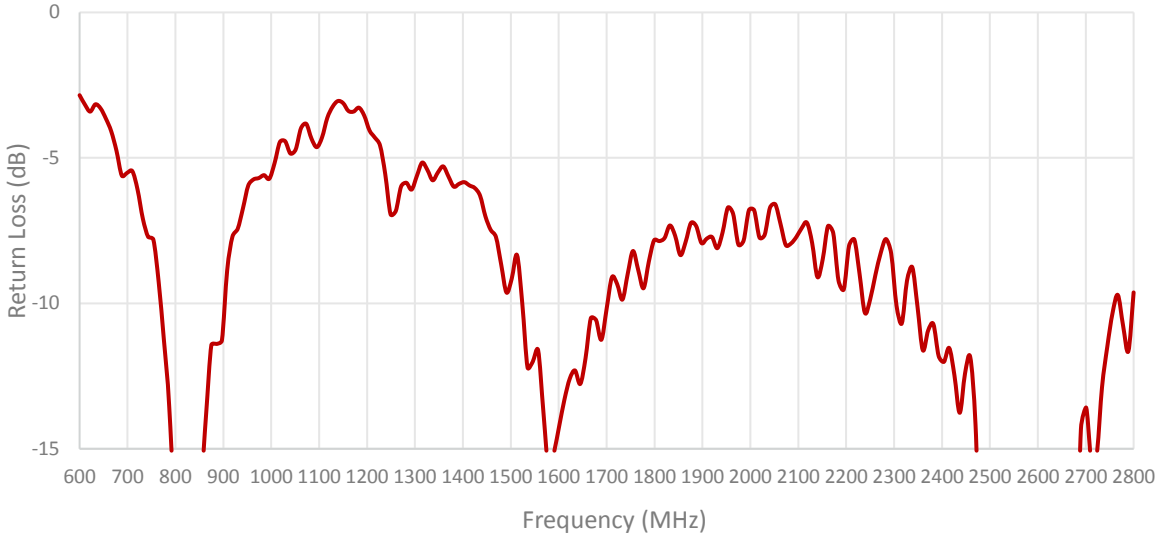
Parameters	GPS/GLONASS Antenna	
	GPS/QZSS/Galileo	GLONASS
<b>Standard</b>		
<b>Band (MHz)</b>	1575	1602
<b>Frequency(MHz)</b>	1575.42	1598-1606
<b>Patch Size (mm)</b>	18 × 18 × 4	
<b>Return Loss (dB)</b>	<= -15.0 dB	
<b>VSWR</b>	<= 1.4:1 dB	
<b>Impedance</b>	50	
<b>Radiation Pattern</b>	Hemispherical	
<b>Polarization</b>	RHCP	
<b>Saw Filter</b>	Pre-filter	
<b>Active Gain (dB)</b>	28 @ 2.7 V	
<b>Noise Figure (dB)</b>	1.5 Typ	
<b>Voltage (V)</b>	1.5 – 3.6	
<b>Current (mA)</b>	9 Typ	
<b>Power Consumption (mW)</b>	24.3 Typ	
<b>ESD Protection (kV)</b>	2kV	
<b>Connector Type</b>	SMA-Male Standard (Other Connectors Available)	
<b>Cable Length</b>	300 cm Standard (Any Cable Length Available)	
<b>Cable Type</b>	D100 Standard (Other Cables Available)	

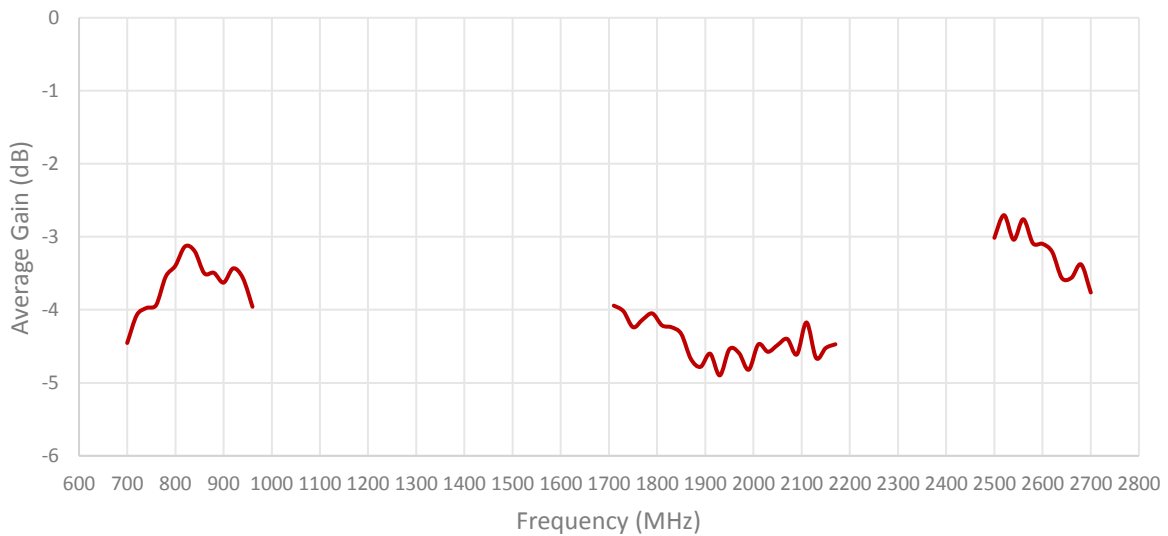
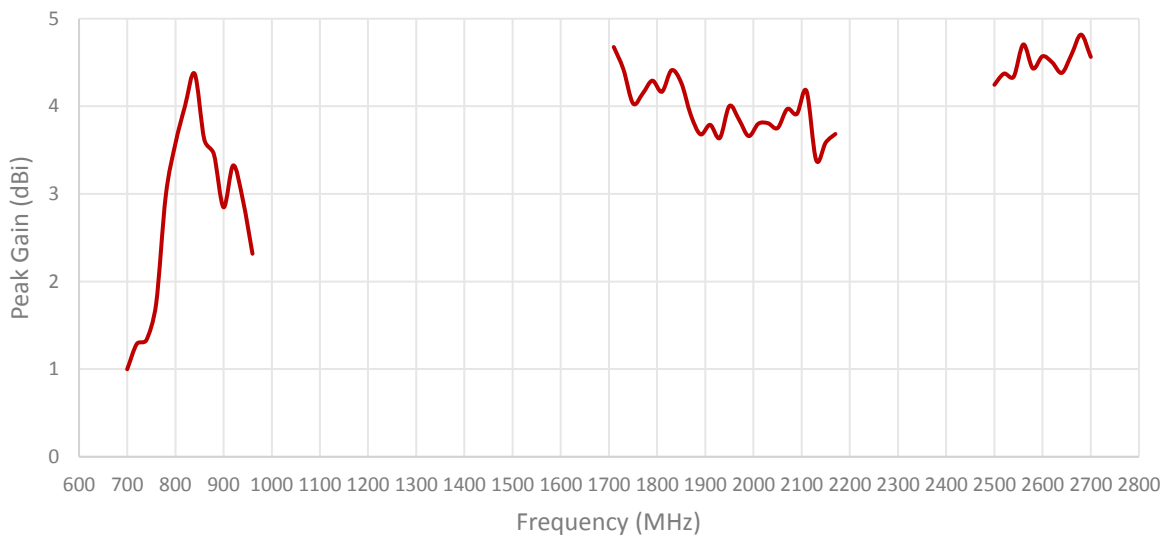
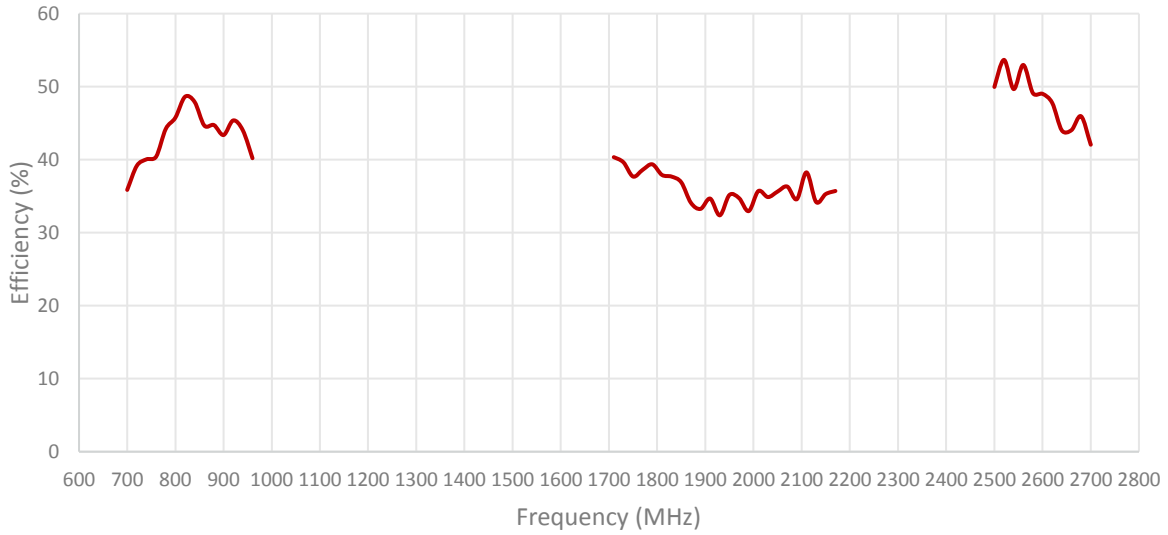
## 2. Mechanical and environmental specifications

Specifications	2J6941BGFa
<b>Mounting Type</b>	Screw Mount
<b>Dimensions (mm)</b>	80 x 74 x 25.6
<b>Radome Type</b>	ASA UV Stable
<b>Radome Color</b>	Black, White
<b>Operating Temperature (C)</b>	-40 to +85
<b>Storage Temperature (C)</b>	-40 to +85
<b>Substance Compliance</b>	RoHS
<b>Certificates</b>	IP67, IP69

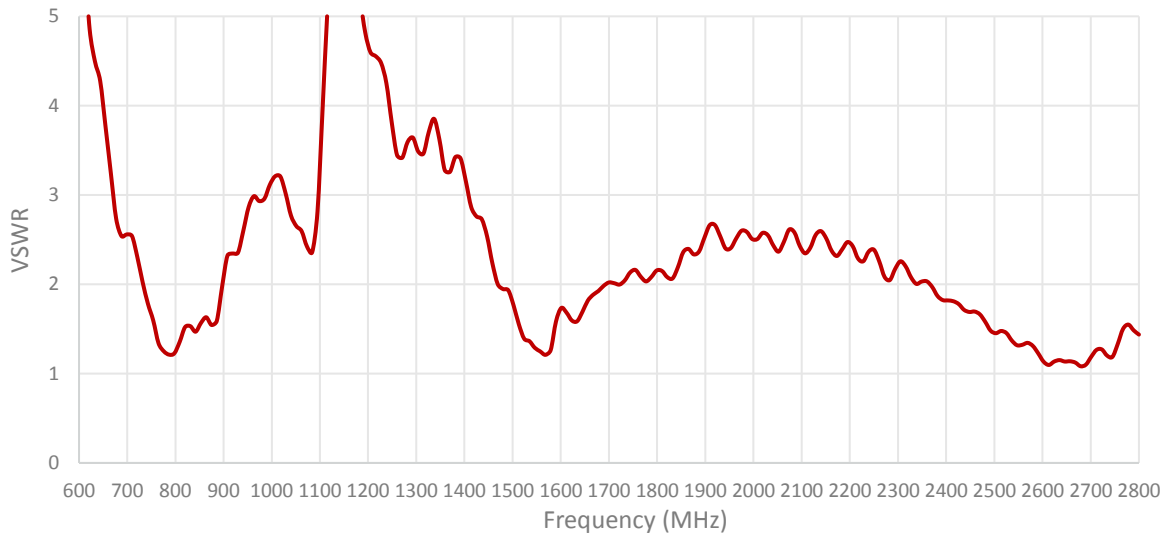
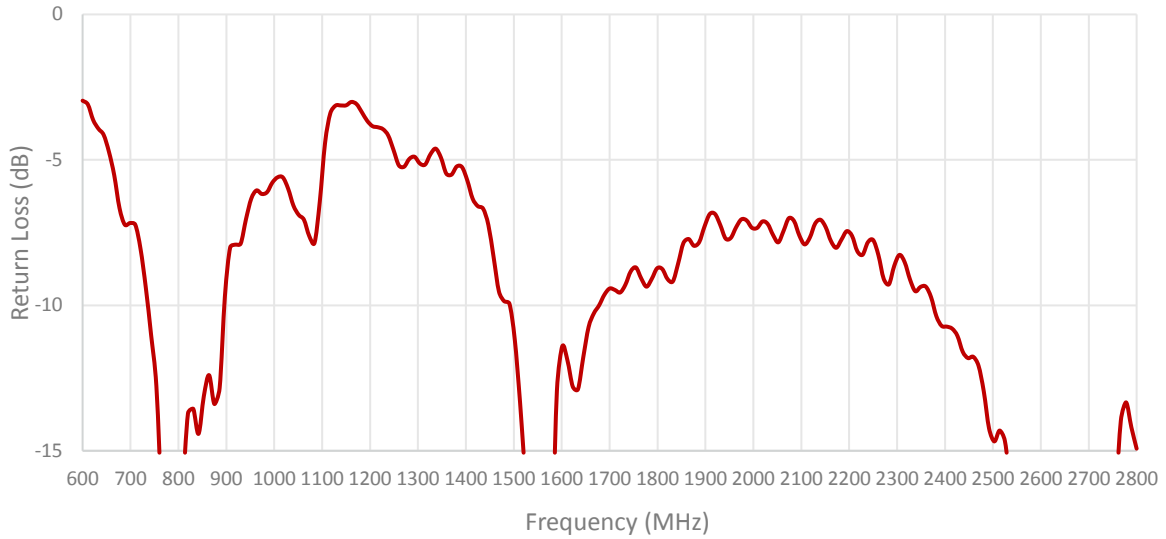
### 3. Antenna parameters

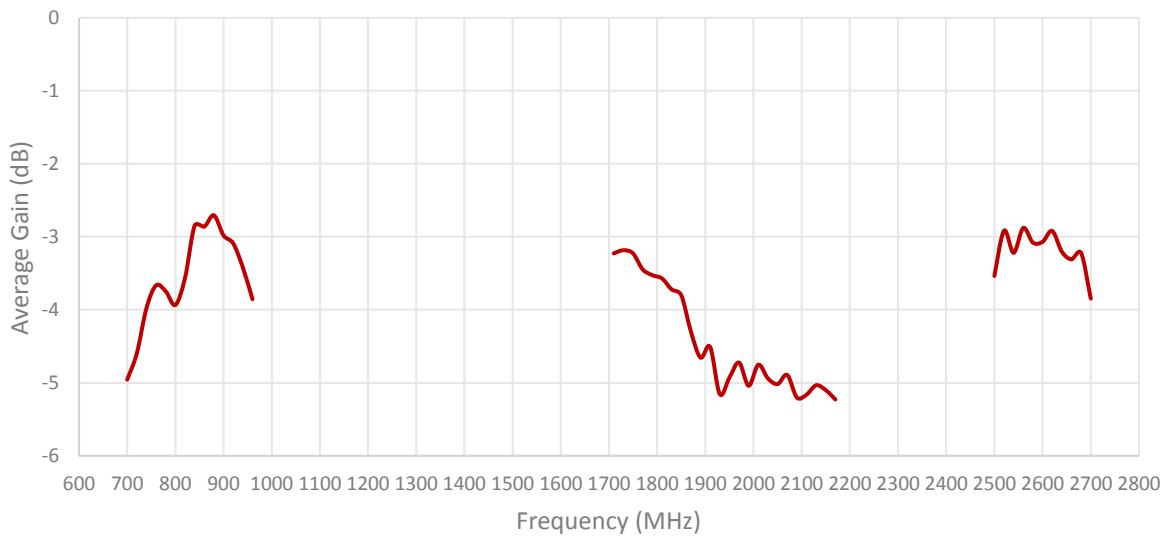
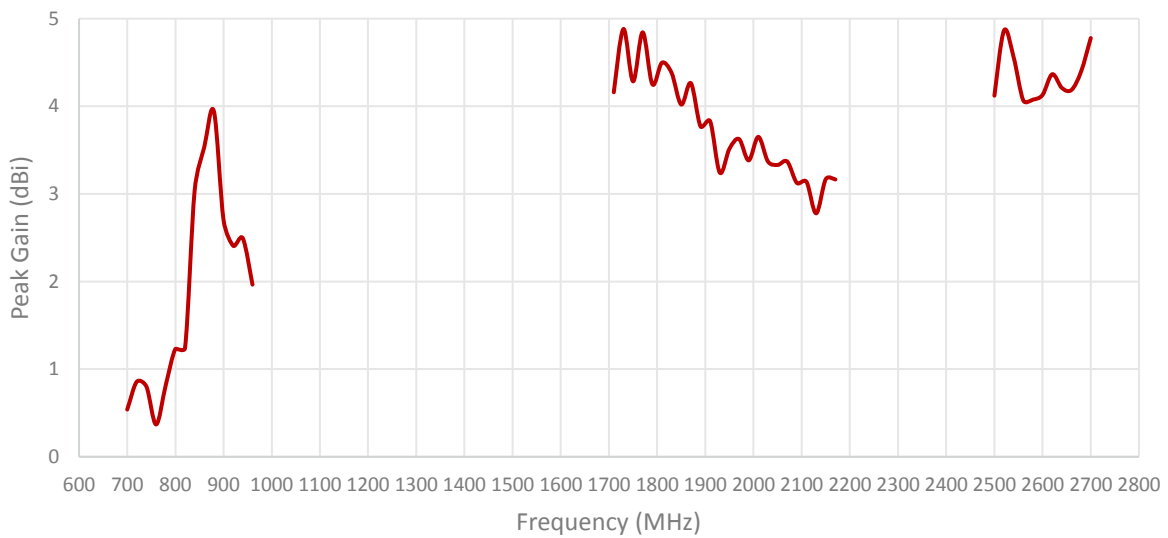
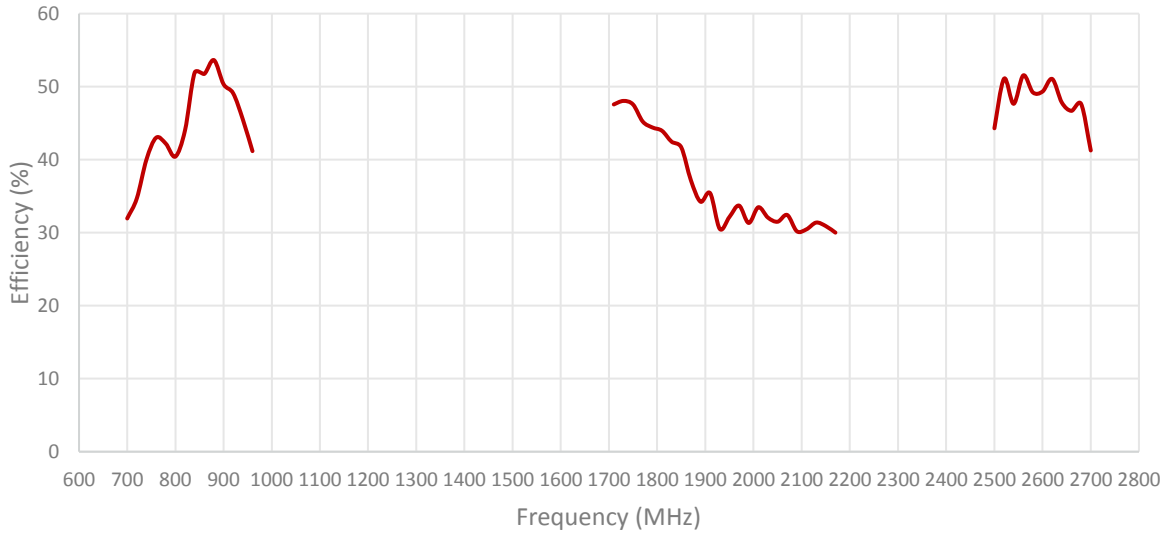
Cable 1: CELLULAR/LTE



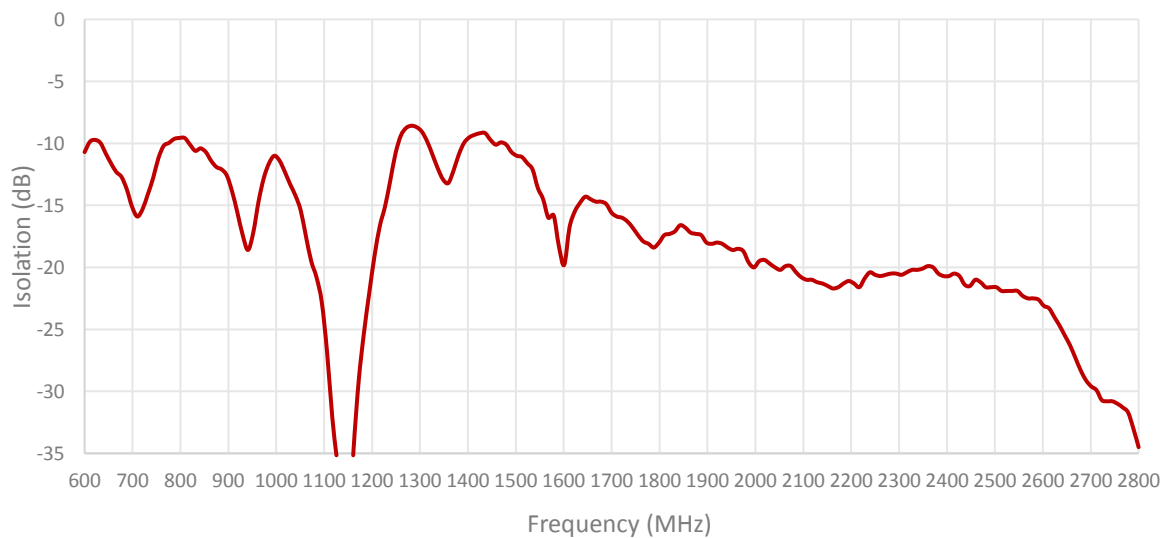


**Table 2: CELLULAR/LTE**

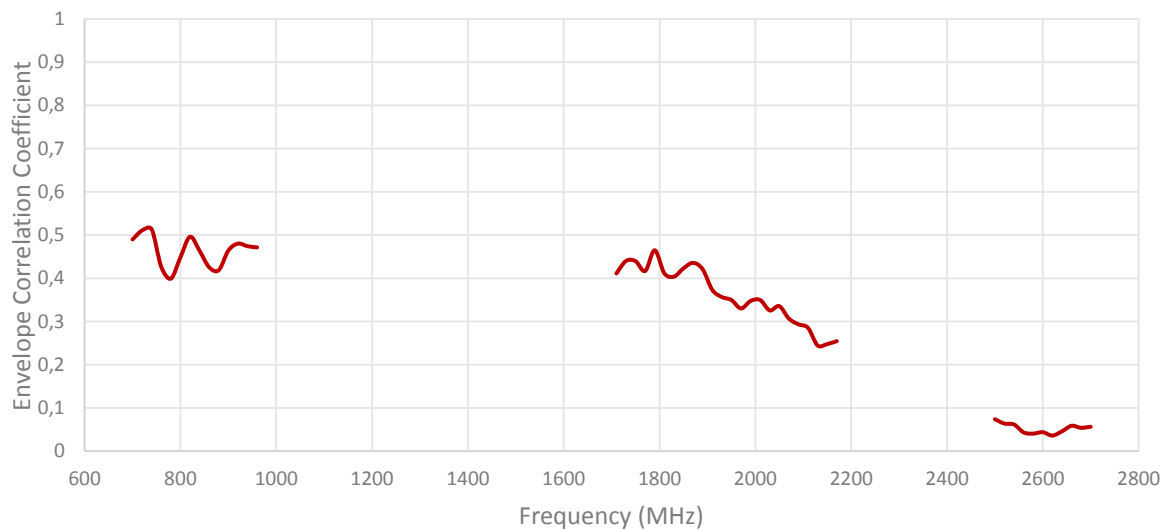




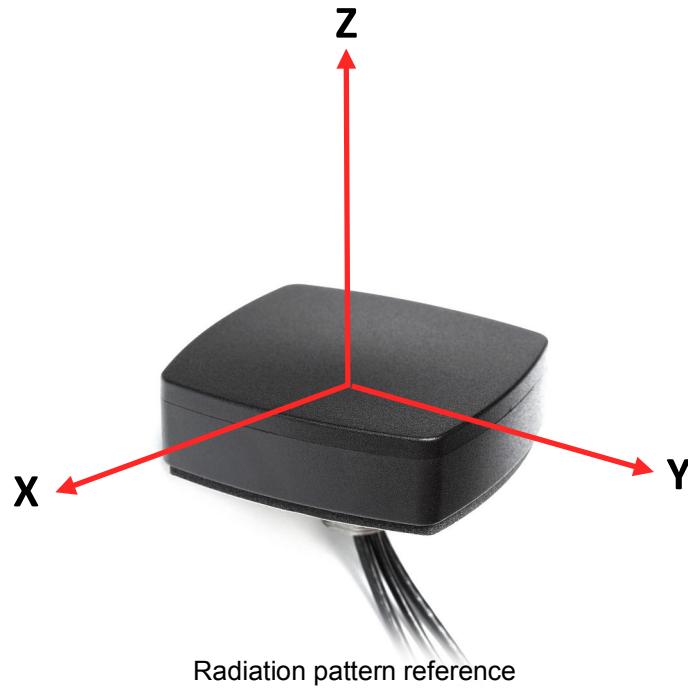
**ISOLATION FOR CABLES 1 AND 2**



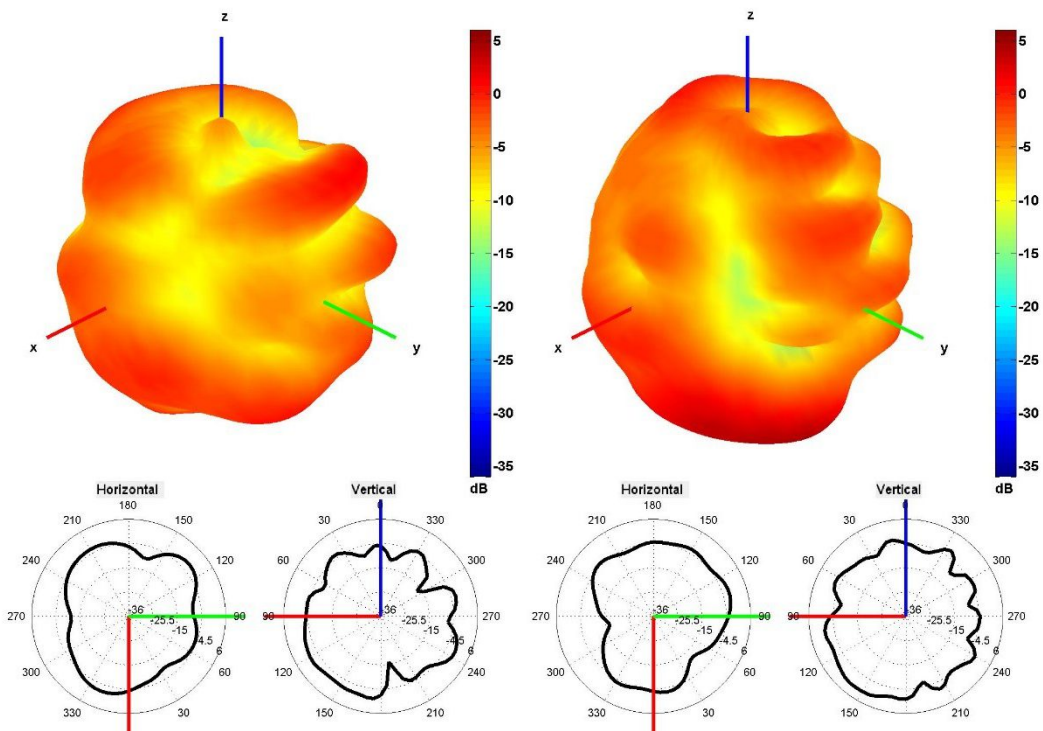
**ENVELOPE CORRELATION COEFFICIENT FOR CABLES 1 AND 2**

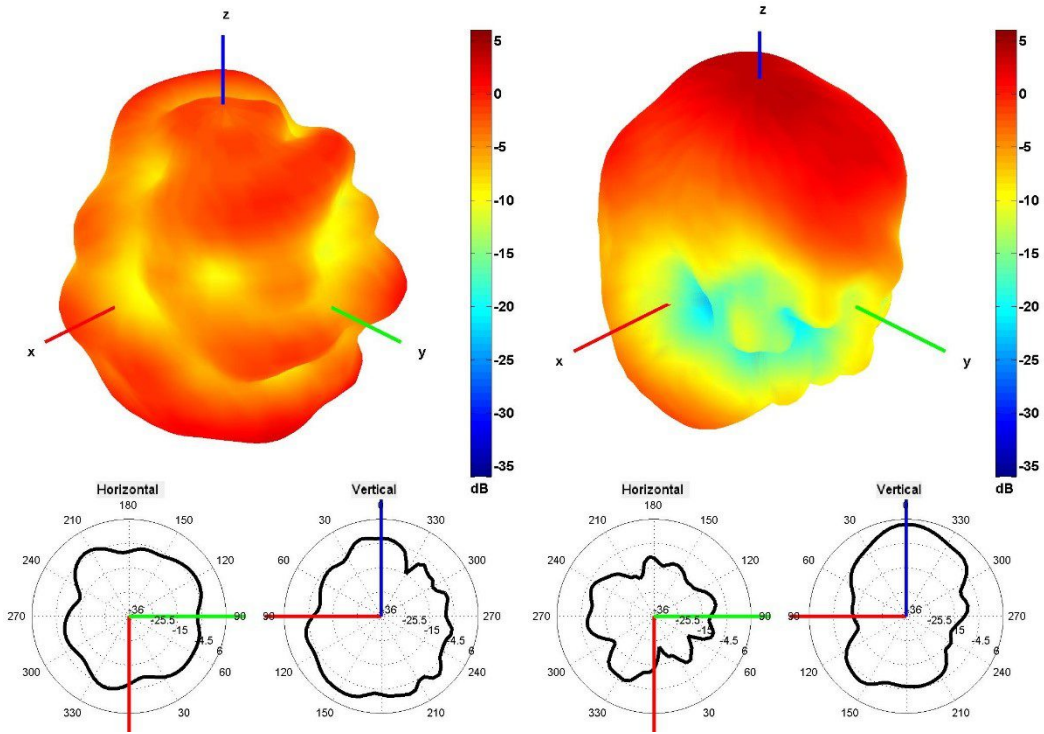




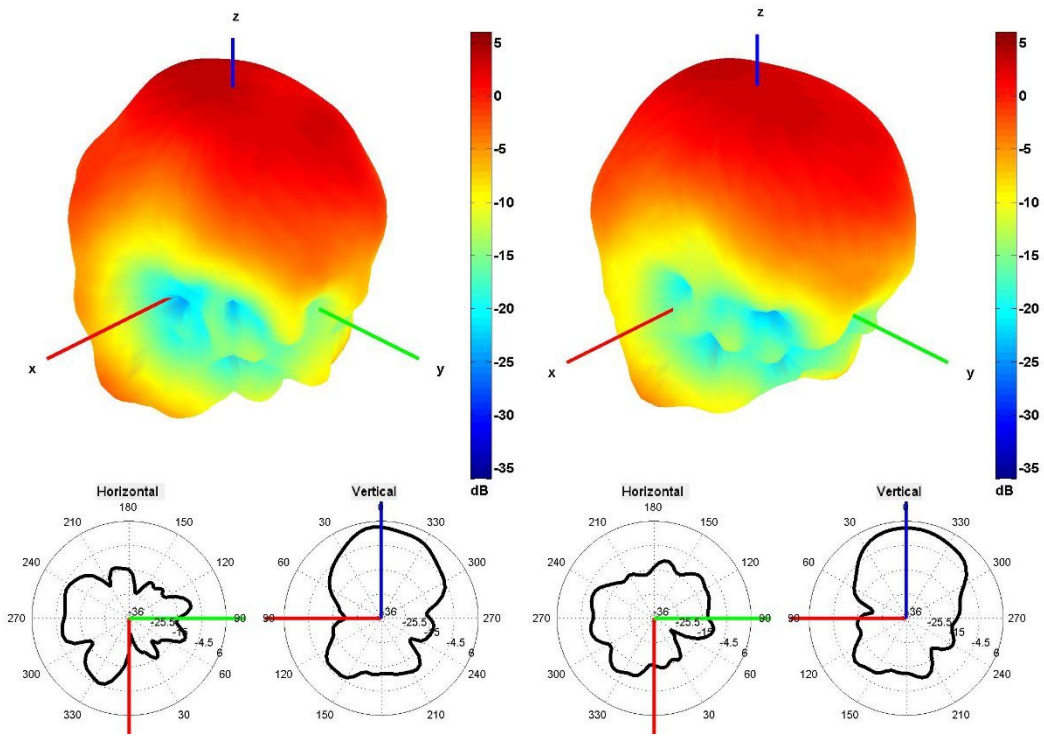


Cable 1: CELLULAR/LTE

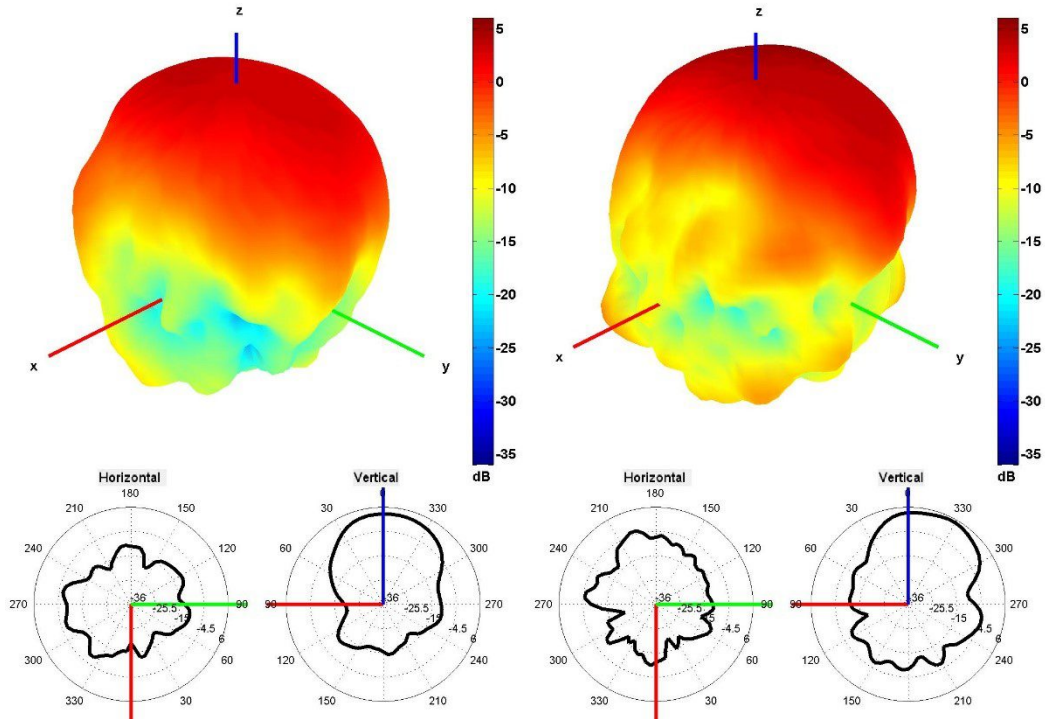




940 and 1750 MHz Radiation pattern

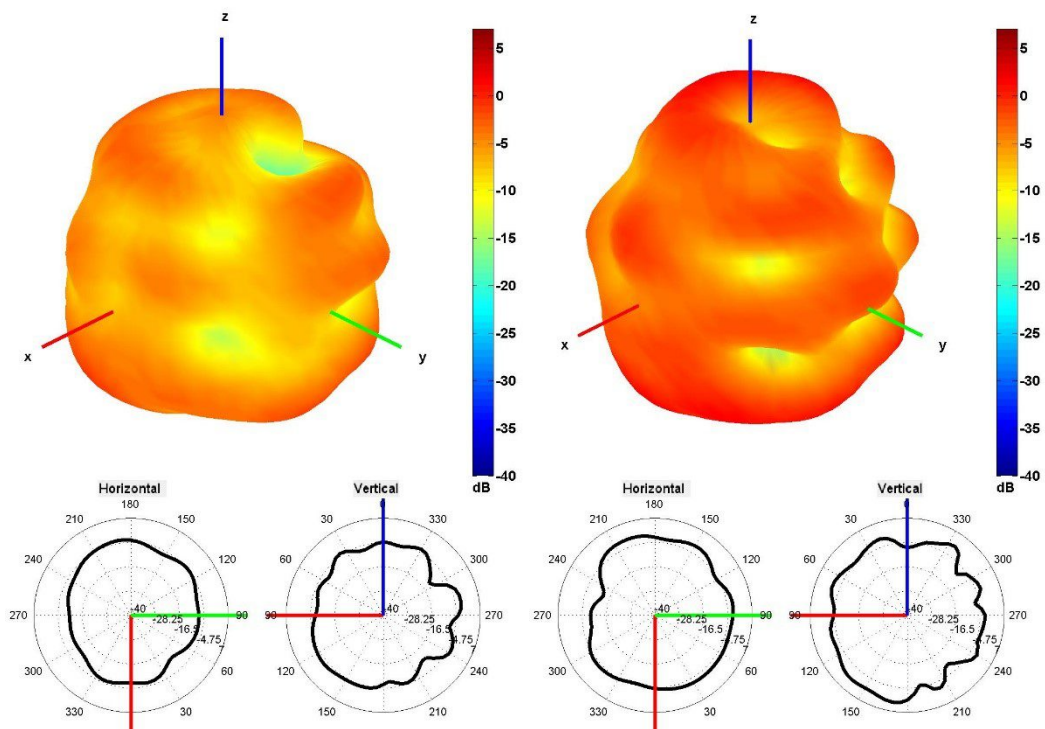


1850 and 1950 MHz Radiation pattern

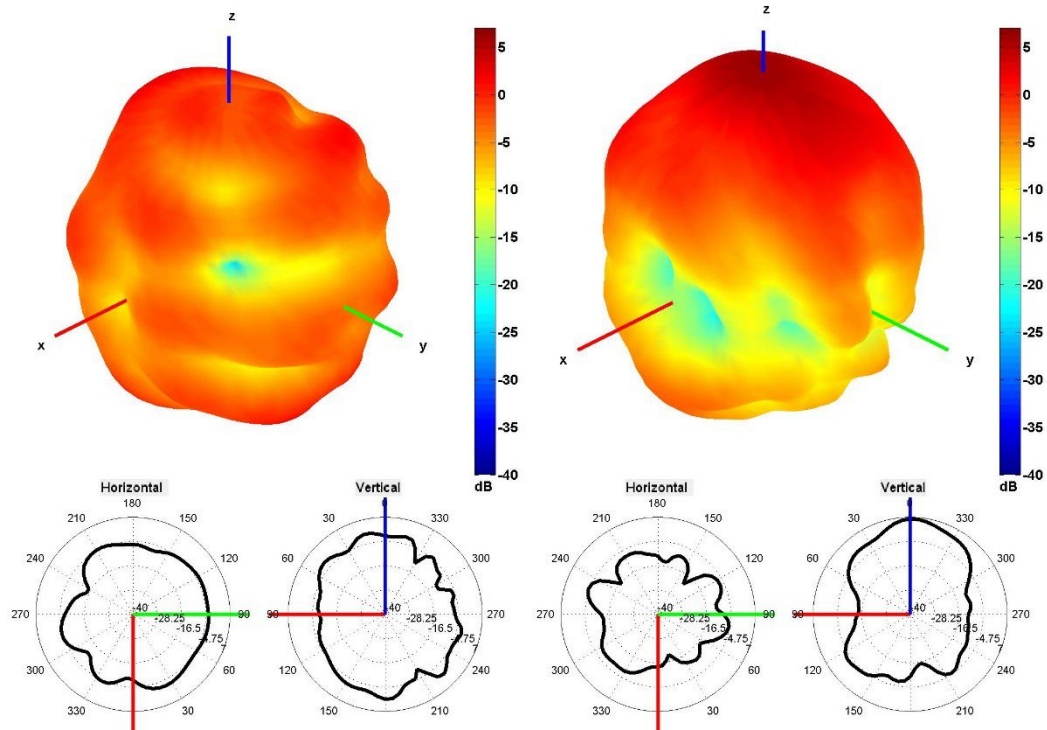


2100 and 2600 MHz Radiation pattern

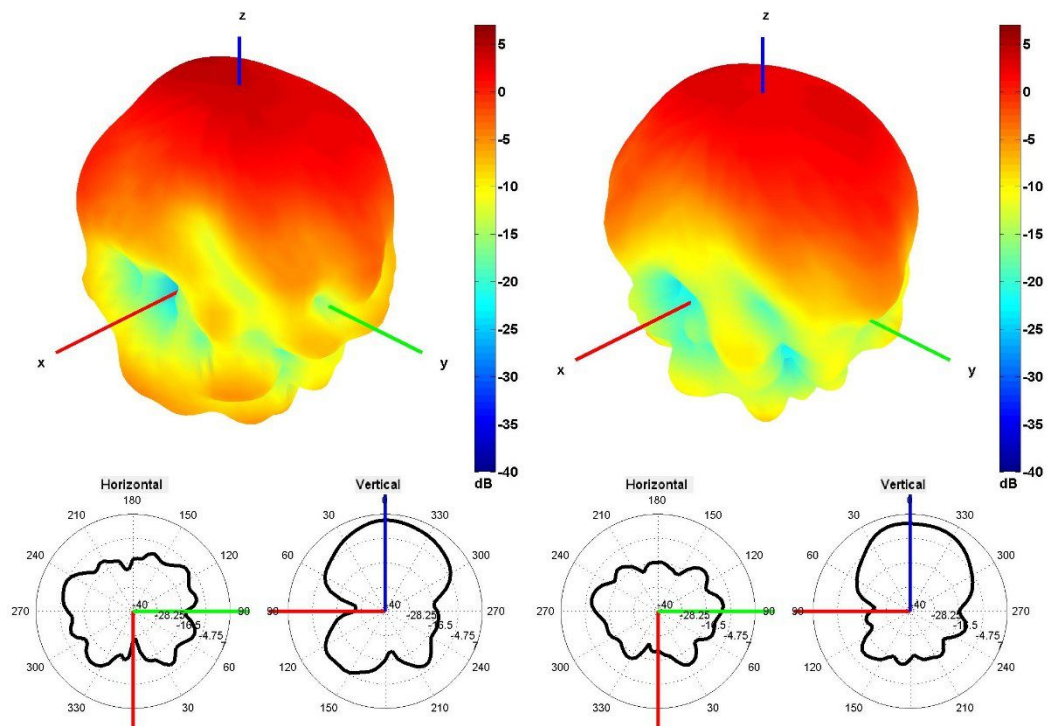
Cable 2: CELLULAR/LTE



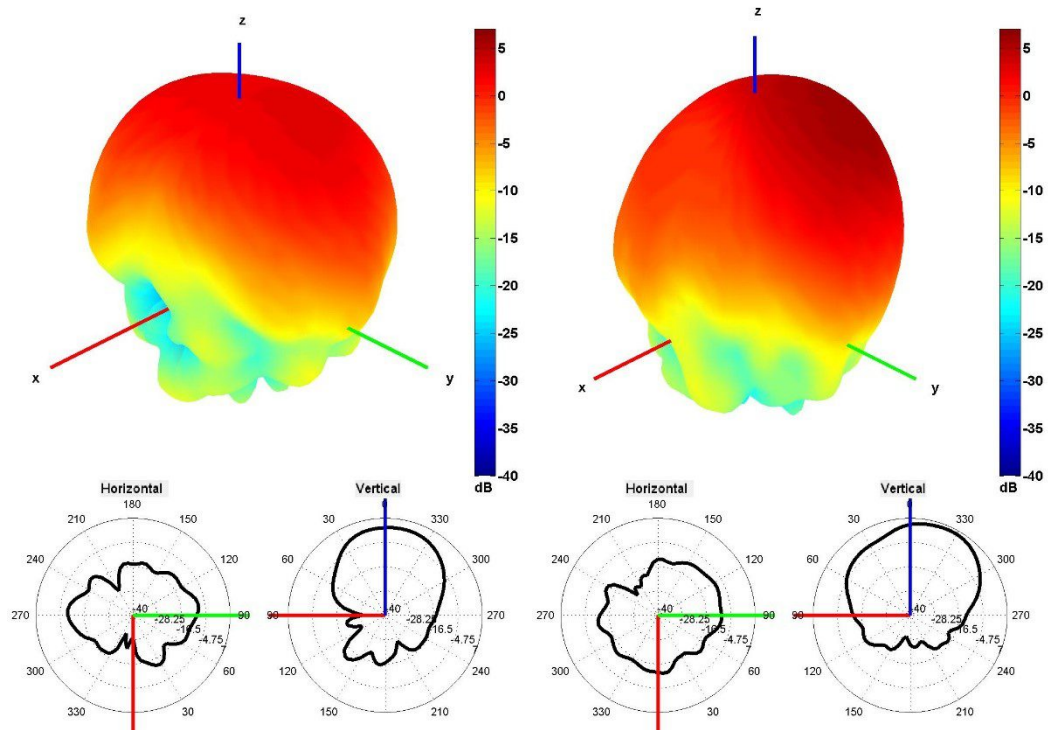
740 and 850 MHz Radiation pattern



940 and 1750 MHz Radiation pattern

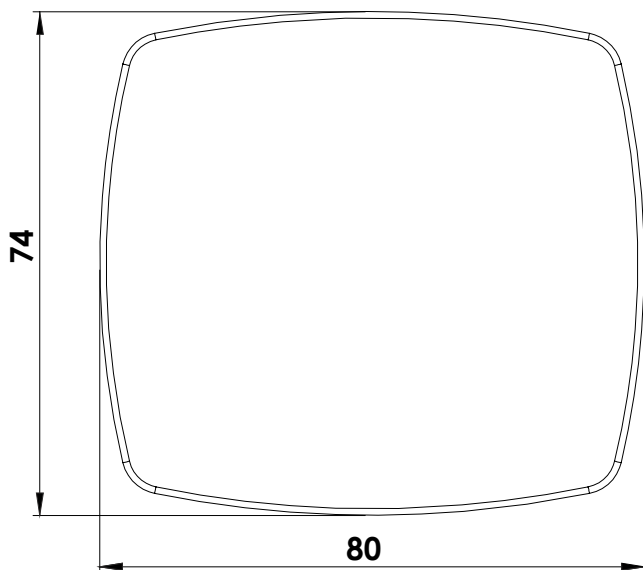
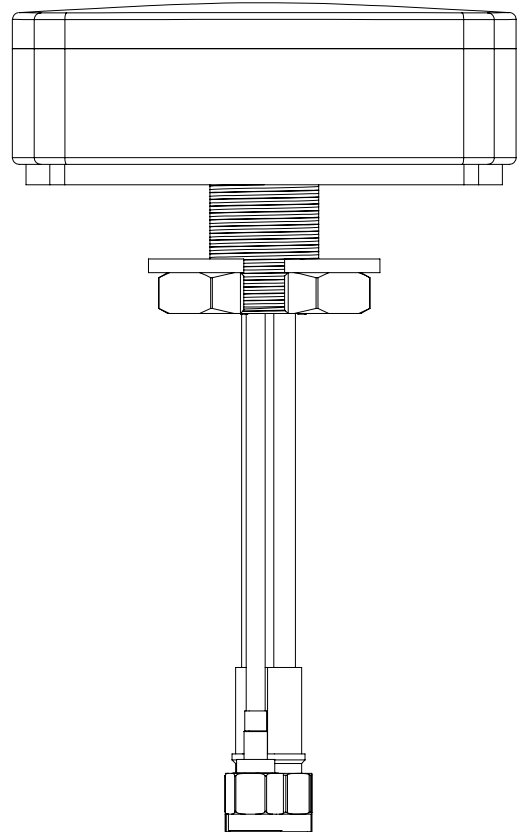
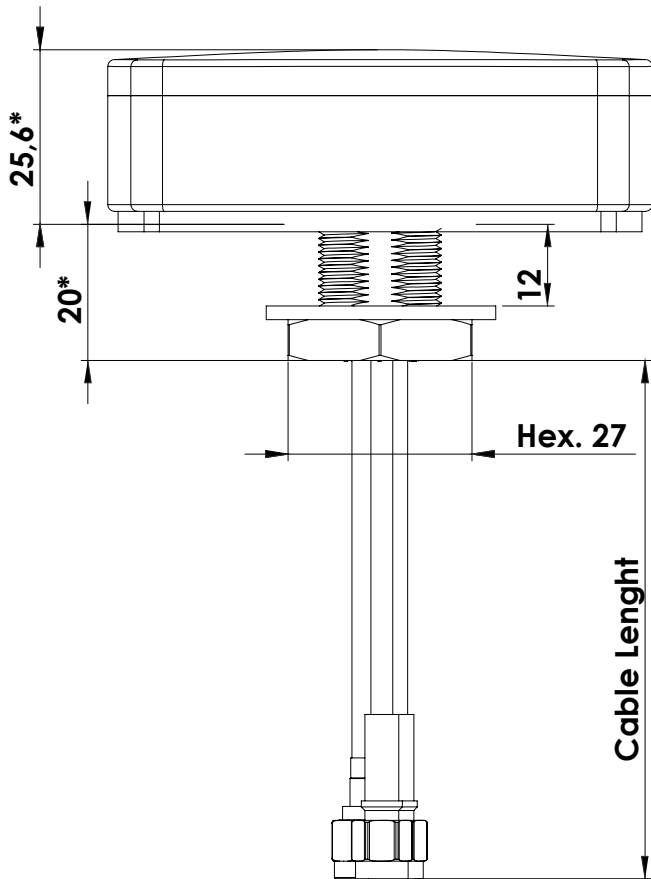


1850 and 1950 MHz Radiation pattern

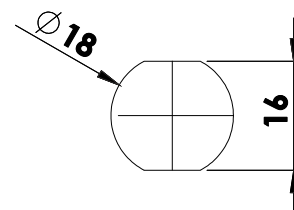


2100 and 2600 MHz Radiation pattern

## 4. Antenna drawings



Mounting hole



Max. mounting thickness 12mm

\* Dimensions after mounting



## 5. Antenna Images

